

# SEATBELT INSTALLATION GUIDE



## SEATBELT

- 2 Inch Non Retractable
- 2 Inch Non Retractable Chrome
  - 2 Inch Retractable
- 3 Inch Non Retractable Chrome
  - 3 Inch Retractable

## STANDARD BOLT KIT

For the E Series, F Series, J Series, K Series, M400 Series, T Series & KAB.

Ultra Part #	Description	Qty.
200-218	Spacers	4
200-114	2-1/4" x 7/16" Fine Threaded Bolt	2
200-111	1-1/2" x 7/16" Fine Threaded Bolt	2
810-65LWSR	7/16" Lock Washer	2
810-65WSR	7/16" Flat Washer	2
810-65LN	7/16" Lock Nut	2

For the P200 Series \*

Ultra Part #	Description	Qty.
200-218	Spacers	4
* 200-174	M12 x 50mm Bolt 8.8	2
810-65LWSR	7/16" Lock Washer	2
* 200-178	M12 Lock Washer	2

\*P200 Series Bolts & Lock Washers NOT INCLUDED in Standard Kit Package.

Belt is for one seated individual.

Please visit [www.ultraseat.com](http://www.ultraseat.com) for more information regarding this product.

## BOLT KIT



\*P200 Bolt Kit NOT Shown.

Push fabric to confirm hole location, slit fabric with razor/knife

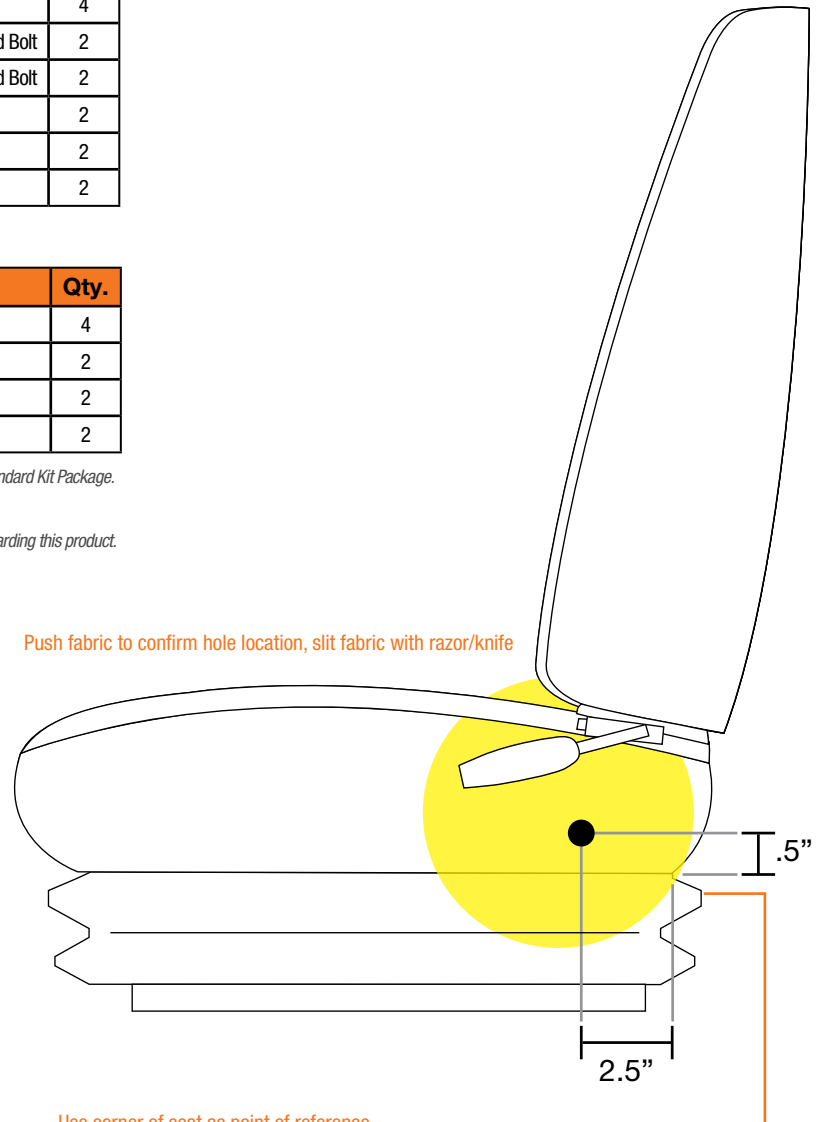

Use corner of seat as point of reference

\* Approximate Dimensions

SCAN FOR GUIDES



Guides also available at:  
<https://www.ultraseat.com/downloads>

#81065 & 81067

Call Support 1-800-667-7328

[www.ultraseat.com](http://www.ultraseat.com)

UPDATED: 27/11/23

# SEATBELT INSTALLATION GUIDE



Parts Required for Installation		
200-218	Spacers	2
200-111	1-1/2" x 7/16" Bolt	2
810-65LWSR	7/16" Lock Washer	2
810-65WSR	7/16" Flat Washer	2
810-65LN	7/16" Lock Nut	2

Place the seat belt (retractor or buckle) onto the bolt first. Followed by 1 spacer, then put the bolt through the hole in the frame.

Once the bolt is through the hole in the frame use the flat washer, then lock washer and tighten with the lock nut.

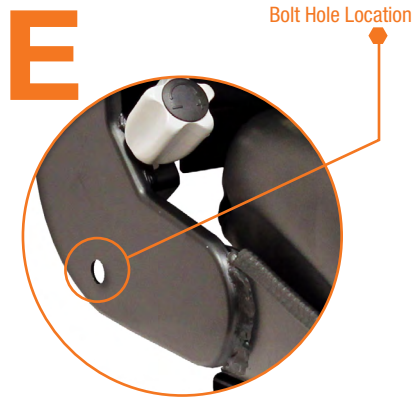

Locate the weld nut as indicated in the illustration to the right. Carefully puncture the fabric using a razor knife. Typically an "X" cut works the best.

Place the lock washer then flat washer on the bolt first. Then place the seat belt (retractor or buckle) onto the bolt followed by 2 spacers last.

Thread the bolt into the weld nut in the frame and tighten.

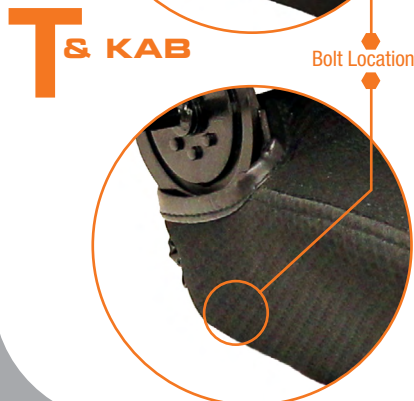
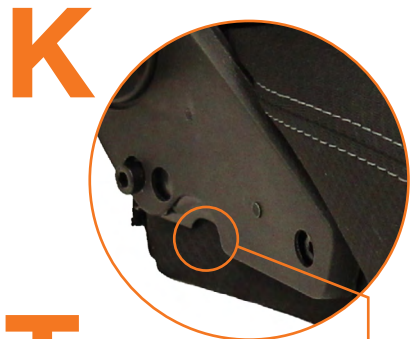

Parts Required for Installation		
200-218	Spacers	2
200-111	1-1/2" x 7/16" Bolt	2
810-65LWSR	7/16" Lock Washer	2
810-65WSR	7/16" Flat Washer	2
810-65LN	7/16" Lock Nut	2

Place the seat belt (retractor or buckle) onto the bolt first. Followed by 1 spacer, then put the bolt through the hole in the frame.

Once the bolt is through the hole in the frame use the flat washer, then lock washer and tighten with the lock nut.

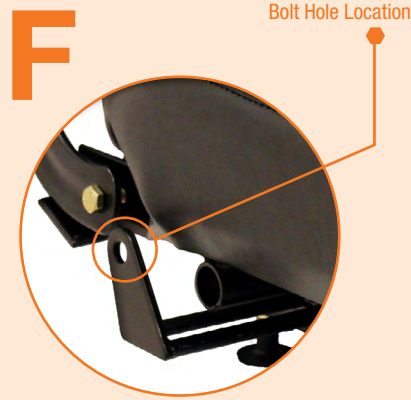

Parts Required for Installation		
200-218	Spacers	2
200-111	1-1/2" x 7/16" Bolt	2
810-65LWSR	7/16" Lock Washer	2
810-65WSR	7/16" Flat Washer	2

Remove protective plastic cover and discard to reveal weld nut.

Place the lock washer then flat washer on the bolt first. Then place the seat belt (retractor or buckle) onto the bolt followed by 1 spacer.

Thread the bolt into the weld nut in the frame and tighten.

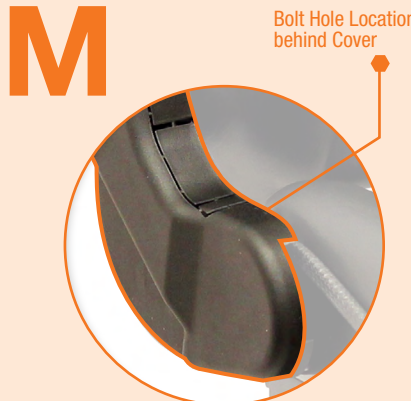

Parts Required for Installation		
200-218	Spacers	4
200-114	2-1/4" x 7/16" Bolt	2
810-65LWSR	7/16" Lock Washer	2
810-65WSR	7/16" Flat Washer	2

Pop out plastic insert in Bolt Hole Location to reveal weld nut.

Place the lock washer then flat washer on the bolt first. Then place the seat belt (retractor or buckle) onto the bolt followed by 1 spacer.

Thread the bolt into the weld nut in the frame and tighten.

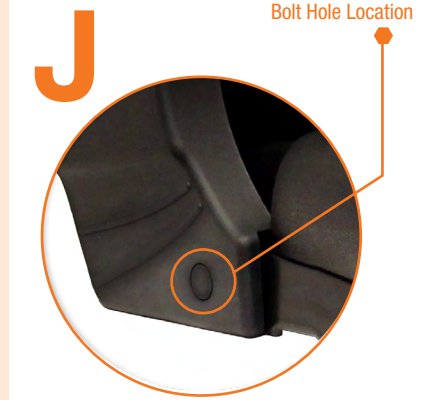

Parts Required for Installation		
200-218	Spacers	4
* 200-174	M12 x 50mm Bolt 8.8	2
810-65WSR	7/16" Flat Washer	2
*200-178	M12 Lock Washer	2

Place the lock washer then flat washer on the bolt first. Then place the seat belt (retractor or buckle) onto the bolt followed by both spacers last.

Thread the bolt into the weld nut in the seat pan and tighten.

*\*P200 Series Bolts & Lock Washers NOT INCLUDED in Standard Kit Package.*

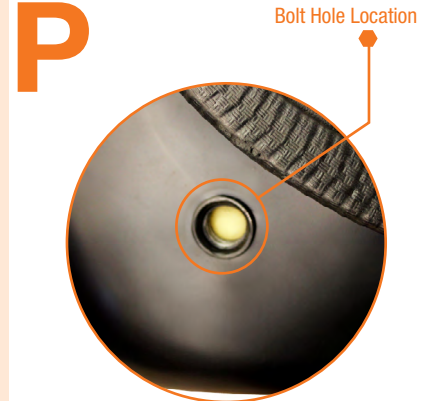

SCAN FOR GUIDES



Guides also available at:  
<https://www.ultraseat.com/downloads>

##81065 & 81067